

## High-resolution Progressive scan Monochrome CCD Camera

# KP-F100B/F100BCL/F100UV

RS-232C control, Effective picture elements number 1.45 million,  
Progressive scan with full pixel independent readout

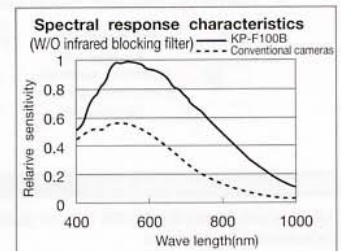

- **High resolution :**  
High grade CCD with 1392(H)X1040(V) effective square lattice pixels.  
UV : from 240 nm approx. ~to 930 nm approx. sensitivity CCD with 1392(H)X1040(V) effective square lattice pixels
- **Digital output and analog output :**  
An EIA-644 digital output is provided. Camera-Link (KP-F100BCL)
- **Frame on demand :**  
An external trigger signal input can be used to capture an image at a

desired timing for instant view or processing. The capture time can be adjusted by the trigger and shutter.

- **RS-232C Control :**  
The self-contained CPU permits using RS-232C control for setting each function, Frame on demand, Trigger input pulse invert, etc. The functions can also be set from rear panel switches.
- **Multi step electronic shutter up to 1/50000 second**

### Specifications

	KP-F100B/F100BCL	KP-F100UV
Pickup element	2/3-inch interline CCD	1/2-inch interline CCD
Effective pixels	1392(H)X1040(V)	
Pixel pitch	6.45(H)X6.45(V) μm (square lattice)	4.65(H)X4.65(V) μm
Imaging area	8.71(H)X6.90(V) mm	6.47(H)X4.84(V) mm
Scanning system	Progressive	
Aspect ratio	4 : 3	
Frame rate	15 frames/second (full pixel readout) 60 fps (quad speed mode)	7.5 fps 30 fps (quad speed mode)
Horizontal scanning frequency	16.035 kHz	7.98 kHz
Synchronization	Internal/external (automatic switching)	
Lens mount	C-mount	
Flange focal distance	17.526 mm	
Video output	Digital output or analog output for image checking Digital output Camera-Link or EIA-644 single channel	
External sync input	HD/VD TTL level negative Input impedance: 1 kΩ Frequency deviation: ±1 %	
Electronic shutter speed	Off (frame rate), 1/30, 1/125, 1/250, 1/1000, 1/2000, 1/4000, 1/10000, 1/50000 second.	
Frame on demand	External switch setting off, fixed shutter, two trigger and one trigger	
Sensitivity	400 lx F4 3200 K	
Power supply voltage	12 ± 1 VDC	
Current consumption	330 mA approx.	300 mA approx.
Ambient, operating	0 to + 40 °C (+32 to ; 104 F), less than 90 % RH	
Ambient, storage	-10 to + 50 °C (+14 to +122 F), less than 70 % RH	
Vibration endurance	29 m/s <sup>2</sup> , 10 to 55 Hz 30 minutes each on XYZ axes	
Shock endurance	294 m/s <sup>2</sup> (vertical, horizontal, once each face)	
External dimensions	44(W)X44(H)X78(D) mm	
Mass	180 g (6.3 oz) approx.	

### Frame-on-demand Function

With the Frame-on-demand function, moving objects can be captured at an optional or fixed exposure time by supplying a trigger pulse at an optional timing.

#### ● Fixed shutter mode

When one trigger pulse (TRIG A) is supplied, exposure starts at the rising edge of the inputs pulse. Exposure time is fixed, and set by the electrical shutter switches on the camera.

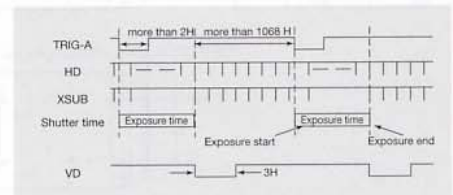

#### ● Two trigger mode

When two trigger pulses (TRIG A and TRIG B) are supplied, exposure starts at the rising edge of the TRIG A pulse, and ends at the falling edge of TRIG B pulse. The period between the two pulses is exposure time.

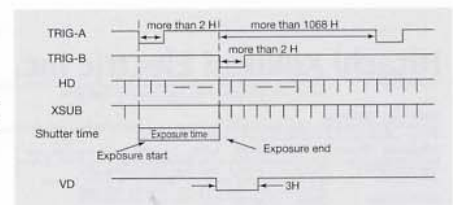

#### ● One trigger mode

When one trigger pulse (TRIG A) is supplied, exposure starts at the rising edge of the inputs pulse, and ends at the falling edge of the inputs pulse. Then, the V-SYNC pulse is reset and picture are delivered immediately. The pulses width is the exposure time.

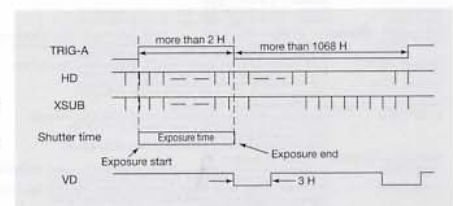

## Rear panel switches

The rear panel includes switches for electronic shutter data, readout rate, and field on demand on/off and mode switches.

### (1) Electronic shutter switches

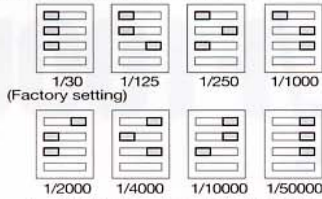

### (2) Remote ON/OFF switch(KP-F100BCL)

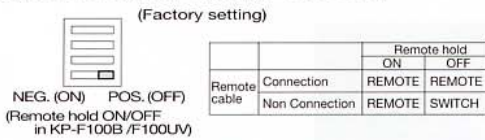

### (3) Frame on demand (FD) ON/OFF switch

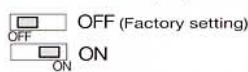

### (4) Frame on demand mode switch

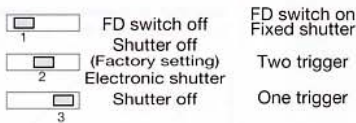

## Standard Composition

- Camera (with infrared blocking filter or quartz glass(F100UV))
- Operating instructions

## Dimensions KP-F100B

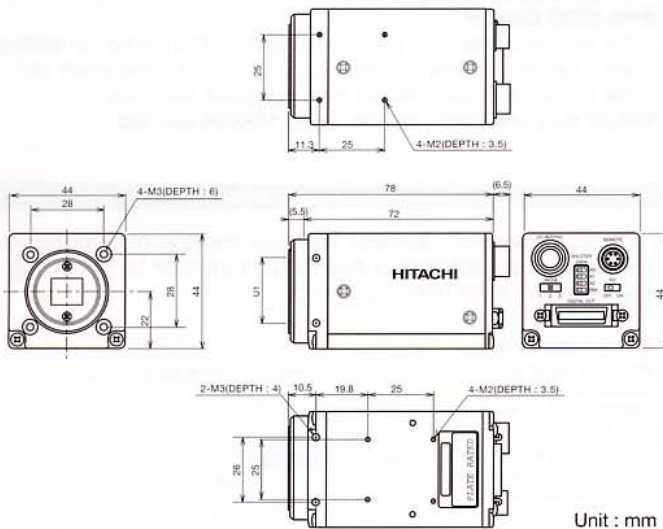

## Pin connections

### ● Connections to DC IN and SYNC (12 pin)

Pin No.	Int. sync	Ext. sync			
		HD/VD	Frame on demand		
			Fixed shutter	Two trigger	One trigger
1	GND	GND	-	GND	GND
2	+12 V	+12 V	GND	+12 V	+12 V
3	GND	GND	+12 V	GND	GND
4	VIDEO	VIDEO	VIDEO	VIDEO	VIDEO
5	GND	EXTHD (GND)	GND	GND	GND
6	-	EXTHD (SIGNAL)	GND	-	-
7	-	EXTVD (SIGNAL)	TRIG-A (SIGNAL)	TRIG-A (SIGNAL)	TRIG-A (SIGNAL)
8	GND	GND	GND	TRIG-B (GND)	GND
9	-	-	-	TRIG-B (SIGNAL)	-
10	GND	GND	GND	GND	GND
11	+12 V	+12 V	GND	+12 V	+12 V
12	GND	EXTVD (GND)	TRIG-A (GND)	TRIG-A (GND)	TRIG-A (GND)

Not connect EXT. input signals in KP-F100BCL

### ● Signal connections to D. OUT (26 pin)

Pin No.	Signal	Pin No.	Signal	Pin No.	Signal
1	DATA0-H	10	DATA4-L	19	DATA9-H
2	DATA0-L	11	DATA5-H	20	DATA9-L
3	DATA1-H	12	DATA5-L	21	VD-H
4	DATA1-L	13	DATA6-H	22	VD-L
5	DATA2-H	14	DATA6-L	23	HD-H
6	DATA2-L	15	DATA7-H	24	HD-L
7	DATA3-H	16	DATA7-L	25	CLK-H
8	DATA3-L	17	DATA8-H	26	CLK-L
9	DATA4-H	18	DATA8-L	Shield	GND

### ● Remote (RS-232C control) cable pin connections (6pin)

Pin No.	Signal name
1	-
2	RD
3	TD
4	Manual/remote
5	Ground
6	-

## Optional accessories

- Junction box.....JU-M1A (23831AX)  
JU-F1 (23832AX)
- Camera cable  
(Molded type) 2 m C-201KSM  
5 m C-501KSM  
10 m C-102KSM
- AC adaptor.....117 V:AP-130U(23805UX)  
230 V:AP-130E(23805EX)
- Tripod adaptor.....TA-M1(23855AX)
- Quartz glass (KP-F100UV)
- Dummy glass (AR coated)...ARC1214(XMD0009)
- 6 pin Remote plug.....HR10A-7P-6P
- 12 pin plug.....HR10A-10P-12S(01)  
(23810AX)
- D.OUT connector (26 pins).....EIA-644 DX30AM-26P  
Camera-Link 10126-6000

## Camera-Link Digital out connector (KP-F100BCL)

Pin No.	Signal	Pin No.	Signal
1	GND	14	GND
2	TXOUT 0 (-)	15	TXOUT 0 (+)
3	TXOUT 1 (-)	16	TXOUT 1 (+)
4	TXOUT 2 (-)	17	TXOUT 2 (+)
5	TXCLKOUT (-)	18	TXCLKOUT (+)
6	TXOUT 3 (-)	19	TXOUT 3 (+)
7	RX (+)	20	RX (-)
8	TX (-)	21	TX (+)
9	TRIG-A/VD (-) [CC1 (-)]	22	TRIG-A/VD (+) [CC1 (+)]
10	TRIG-B (+) [CC2 (+)]	23	TRIG-B (-) [CC2 (-)]
11	EXT-HD (-) [CC3 (-)]	24	EXT-HD (+) [CC3 (+)]
12	NC [CC4 (+)]	25	NC [CC4 (-)]
13	GND	26	GND

## Hitachi Kokusai Electric Inc.

Head Office : 14-20 Higashi-Nakano 3-chome, Nakano-ku, Tokyo 164-8511, Japan  
Phone : +81 (0) 3-3368-6111, Fax : +81 (0) 3-3365-9119  
URL: http://www.h-kokusai.com

**Beijing Office**  
Beijing Fortune Building 5, Dong San Huan Bei-lu, Chao Yang District, Beijing, 100004 China  
Phone : +86 (0) 10-6590-8755/8756, Fax : +86 (0) 10-6590-8757

**Hitachi Denshi America, Ltd.** URL: http://www.hitachi.com

**Headquarters and Northeast Office**  
: 150 Crossways Park Drive, Woodbury, New York 11797, U. S. A.  
Phone : (+1) 516-921-7200, Fax : (+1) 516-496-3718

**West Office**  
: 371 Van Ness Way, Suite 120 Torrance, CA, 90501, U. S. A.  
Phone : (+1) 310-328-6116, Fax : (+1) 310-328-6252

**Midwest Sales**  
: (+1) 330-334-4115, Fax : (+1) 516-496-3718  
Service : (+1) 734-721-6180

**South Sales**  
: Phone : (+1) 770-872-4724, Fax : (+1) 516-496-3718  
Service : (+1) 678-937-0291

**Paris Center**  
: Phone : (+1) 516-682-4435, Fax : (+1) 516-921-0993

**Latin Sales**  
: Phone : (+1) 516-682-4420, Fax : (+1) 516-496-3718

**Hitachi Denshi Canada, Ltd.** URL: http://www.hitachidenshi.ca

**Head Office**  
: 1 Select Avenue Unit#11 Scarborough, Ontario M1V 5J3, Canada.  
Phone : (+1) 416-299-5900, Fax : (+1) 416-299-0450

**Eastern Office**  
: 5765 Chemin St. Francois St. Laurent, Quebec H4S 1B6, Canada  
Phone : (+1) 514-332-6687, Fax : (+1) 514-335-1664

**Ottawa Office**  
: 9 Antares Drive, Nepean, Ontario, K2E 7V5, Canada  
Phone : (+1) 613-727-3930, Fax : (+1) 613-825-4253

**Hitachi Denshi (Europa) GmbH**

**Head Office**  
: Westlicher StraÙe 80, Jügestheim D-63110 Rodgau, Germany  
Phone : +49 (0) 6106-69020, Fax : +49 (0) 6106-16906

URL : www.hitachi-denshi.de  
General email address : webmaster@hitachi-denshi.de

**Hitachi Denshi (U. K.) Ltd.**

**Head Office**  
: 14 Garrick Industrial Centre, Irving Way, Hendon, London, NW9 6AQ, United Kingdom  
Phone : +44 (0) 208-202-4311, Fax : +44 (0) 208-202-2451

**Leeds Office**  
: Brookfield House, Selby Road, Garforth, Leeds LS25 1NB United Kingdom  
Phone : +44 (0) 113-287-4400, Fax : +44 (0) 113-287-4260

URL : www.hitachi-denshi-uk.com  
General email address : sales@hitachi-denshi-uk.com

Specification are subject to change without notice.